

LED Driver

Product Specifications

ANZ#: Z097d, Oct. 2, 2006

LP1090-XX-YZ-E Series	
Switch-Mode LED Driver	
Total Power	96 Watts
Input Voltages	90-264 VAC or 100-277VAC
Number of Outputs	One

SPECIAL FEATURES

- UL1310 / UL48 Class 2 certified
- Various DC output available, max 96-Watts
- Meet IP64 standards
- Suitable for damp or dry locations
- Suitable for wet location with adequate end plate and connectors
- Designed for outdoor or indoor applications
- Built-in wiring compartments for easy installation (selected models)
- Compact, lightweight w/ aluminum case
- Active PFC to conserve power consumption
- DIN Rail Mounting – Optional

ELECTRICAL SPECIFICATIONS

Input range	90 to 264 VAC, Full range or 100-277VAC
Frequency	47 to 63 Hz
Power Factor	> 0.95 at full load, 115VAC
Crest Factor	1.5 max.
Inrush current	40.0 Amps maximum at 230VAC, cold start, 25° C
Input current	1.5Amps maximum at 90VAC
Efficiency	85% typical at 230VAC and maximum load
EMI filtering	47CFR, Part 2, Part 15 and Cispur PUB, 22 Class A
Maximum power	96W
Current Adjust range	30 ~ 50%
Load regulation	±3%
Leakage Current	0.2mA @ 110VAC, 0.4mA @ 230VAC
Hold up time	Half cycle minimum at 120 VAC and 80% of rated load
Protection	Over-voltage, Over-current, Over-power and Short circuit protection: Auto-recovery

ENVIRONMENTAL

Operating temperature:	-30 to 70 ° C
	(De-rating : 2% per ° C from 50°C)
Storage temperature:	-40 to 85 ° C
Humidity (Non-Condensing):	5% to 95%
Cooling:	Convection
Vibration Frequency:	5 to 50 Hz
MTBF:	>100,000 Hours at full load and 25°C ambient conditions (MIL-217F)
EMC :	Compliant to 47CFR, Part 2, Part15 and Cispur PUB, 22 Class B

SAFETY

UL	UL1310 / UL48 Class 2 certified
CE	Certified

MODEL INFORMATION – SINGLE OUTPUT

Model Numbers	Constant Voltage Mode Output		Constant Current Mode Output		Total output (Watts)
	Adjust range (Vdc)	Current range (A)	Voltage range (Vdc)	Adjust range (A)	
LP1090-36-YZ-E	24 ~ 36	1.0 ~ 2.66	18 ~ 36	1.50 ~ 2.66	96
LP1090-24-YZ-E	18 ~ 24	1.5 ~ 4.00	12 ~ 24	2.50 ~ 4.00	96
LP1090-19-YZ-E	12 ~ 19	2.0 ~ 5.00	10 ~ 19	3.00 ~ 5.00	96

MECHANICAL DRAWING

Model Information – Single DC output

LP1090-XX-YZ-E

XX – DC outputs

Y – AC input side plate options, refer to drawing for more details

Z – DC output side plate options, refer to drawing for more details

E – Aluminum enclosure length, 170, 240, 290mm, refer to drawing for more details

Housing “240”, “290” – The wiring compartment is accessed through side plate only.

Housing “249”, “299” – The wiring compartment can be accessed from the top plate.

MECHANICAL DRAWING (AC INPUT VS. DC OUTPUT)

LP1090-XX-YZ-E

Y – AC input side plate options (Gland not included)

GM-PF21-G

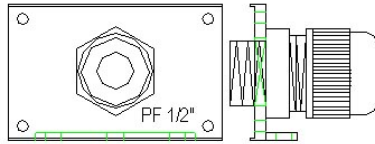

GM-PF13-G



TL-03-T

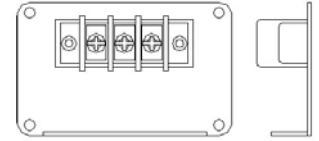

Z – DC output side plate options (Gland not included)

GM-PF21-G

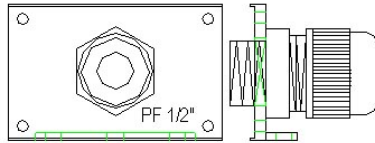

GM-PF13-G



TL-02-T

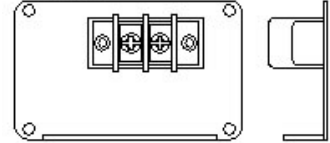

Note: End plates and liquid tight glands for wet location application can be ordered separately.

Housing (E):170

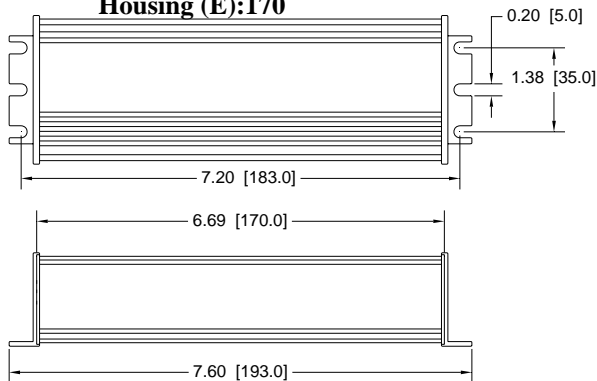

Housing (E):240

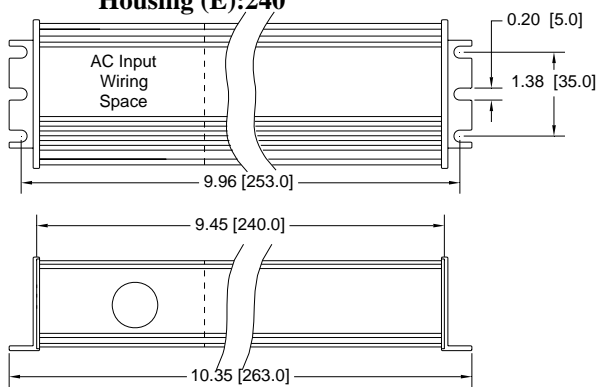

Housing (E):249

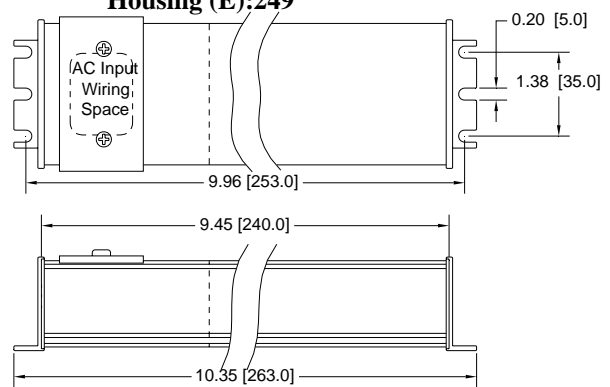

Housing (E):290

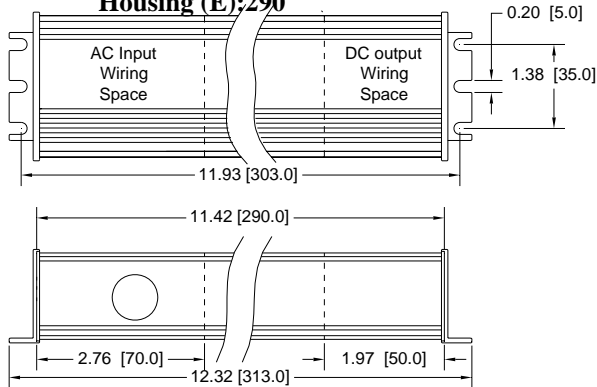

Housing (E):299

